



The Industry Committee for Emergency Lighting Ltd

Email: info@lif.co.uk

Web: www.icef.co.uk

Ground Floor
Westminster Tower
3 Albert Embankment
London SE1 7SL

ICEL 1006: EMERGENCY LIGHTING DESIGN GUIDE

FEBRUARY 2008

ICEL 1006: EMERGENCY LIGHTING DESIGN GUIDE

FEBRUARY 2008

Contents

Foreword	3
Emergency Lighting Terminology	4
Definitions	5
Initial Considerations	8
Legislative Requirements	8
Other U.K. Legislative Requirements	9
Essential Pre-Design Information	10
Design of New Installations	11
Stage 1 Design Procedure	11
Stage 2 The Location and Illumination of Exit Signs	15
Stage 3 Additional Emergency Lighting	18
Stage 4 Illuminance Requirements for Escape Routes	18
Stage 5 Illuminance Levels for Open Areas	21
Stage 6 High Risk Task Area Lighting	23
Stage 7 Choice of Appropriate Emergency Lighting Systems	23
Stage 8 Design Control Procedures	23
Stage 9 Maintenance	25
Checklist for Assessing an Existing Installation	25
Relevant Standards	26
Legislation and Standards Affecting Emergency Lighting	27
The Industry Committee for Emergency Lighting	30
Appendix A	31
Appendix B	35

ICEL 1006: EMERGENCY LIGHTING DESIGN GUIDE – FEBRUARY 2008

Foreword

This guide has been prepared by the Industry Committee for Emergency Lighting (ICEL) it provides information for the use of emergency lighting design engineers to promote a wider understanding of the different types of emergency lighting, and gives guidance on their correct application.

It was developed from the ICEL Guide 1006 which gave guidance to the application of BS 5266-1 and considers the requirements of the new European draft standards as well as the current legislation and codes of practice. The Workplace Directive means that after a risk assessment new harmonised European standards may be retrospectively required to be implemented. ICEL recommends therefore that emergency lighting is designed and installed to the new standards to avoid costly modifications at a later stage.

Navigation through the guide can be achieved by use of the Hyperlinks in the index page

ICEL gratefully acknowledges the support it has received we have received from BSI in the development of this guide

To improve the training and support for engineers practicing emergency lighting system design a joint BSI/ICEL scheme of registration of competent engineers has been developed, details of the scheme and relevant training courses is available from BSI and ICEL

Further information including power point presentations can be obtained from

*The Industry Committee for Emergency Lighting
Westminster Tower
3 Albert Embankment
London SE1 7SL*

Throughout this document, the most up-to-date information available has been used by ICEL. Some documents referred to, and some requirements, are still undergoing review, so please contact ICEL for advice on any changes that may affect the guidance contained in this document.

Compliance with this Guide does not of itself confer immunity from legal obligations.

Feb 2008

Section 1 - Emergency Lighting Terminology

For the purposes of the British and European standard BS EN 1838, **Emergency Lighting** is the generic term for equipment which provides illumination in the event of failure of supply to normal lighting.

There are a number of specific forms, as shown in the figure below:

Specific Forms of Emergency Lighting

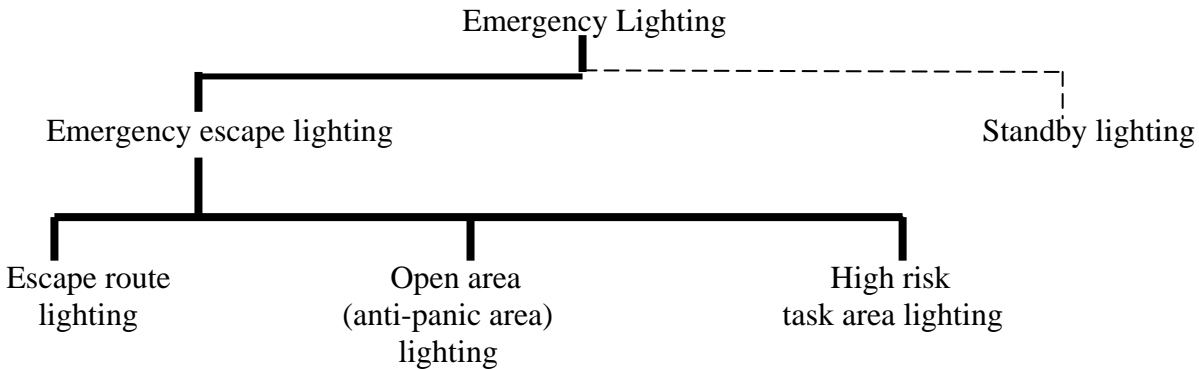

Emergency Escape Lighting

That part of emergency lighting provided to enable safe exit in the event of failure of the normal supply. (This type of emergency lighting forms part of the fire protection system of a building)

Standby Lighting

That part of emergency lighting provided to enable normal activities to continue in the event of failure of the normal mains supply. (This lighting does not provide fire protection unless it meets the same equipment, design and installation requirements as **Emergency Escape Lighting** systems)

Escape Route Lighting

That part of emergency lighting provided to enable safe exit for building occupants by providing appropriate visual conditions and direction finding on escape routes and in special areas/locations, and to ensure that fire fighting and safety equipment can be readily located and used. (e.g.. corridors and stairs)

Open Area (or Anti-Panic Area) Lighting

That part of emergency escape lighting provided to reduce the likelihood of panic and to enable safe movement of occupants towards escape routes by providing appropriate visual conditions and direction finding. (e.g. large rooms)

High Risk Task Area Lighting

That part of emergency lighting provided to ensure the safety of people involved in a potentially dangerous process or situation and to enable proper shut down procedures to be carried out for the safety of other occupants of the premises. (e.g. to protect persons from dangerous machinery).

Definitions

BALLAST

Controls the operation of a fluorescent lamp from a specified AC or DC source (typically between 2.4 and 240 volts). It can also include elements for starting the lamp, for power factor correction or radio frequency interference suppression.

BALLAST LUMEN FACTOR (BLF)

The ratio of the light output of the lamp when the ballast under test is operated at its design voltage, compared with the light output of the same lamp operated with the appropriate reference ballast supplied as its rated voltage and frequency.

BATTERY

Secondary cells providing the source of power during mains failure.

BATTERY SEALED (RECOMBINATION)

A battery that is totally sealed, or constructed so that no provision is made for replacement of electrolyte.

BATTERY UNSEALED (VENTED)

A battery that requires replacement of electrolyte at regular periods.

BATTERY CAPACITY

The discharge capability of a battery, being a product of discharge current and time, expressed as Ampere Hours over a stated duration.

CENTRAL BATTERY SYSTEM

A system in which the batteries for a number of luminaires are housed in one location, usually for all the emergency luminaires in one lighting sub-circuit, sometimes for all emergency luminaires in a complete building.

COMBINED EMERGENCY LUMINAIRE (SUSTAINED)

Contains two or more lamps at least one of which is energised from the emergency supply and the remainder from the normal supply. The lamp energised from the emergency supply in a combined emergency luminaire is either maintained or non-maintained.

DESIGN VOLTAGE

The voltage declared by the manufacturer to which all the ballast characteristics are related.

EMERGENCY EXIT

A way out which is intended to be used any time that the premises are occupied.

'F' MARK

Shows the luminaire can be mounted on combustible surfaces. It does not show that the luminaire is fire retardant.

FINAL EXIT

The terminal point of an escape route, beyond which persons are no longer in danger from fire or any other hazard requiring evacuation of the building.

850°C GLOW WIRE TEST

Enclosures of emergency luminaires on escape routes must pass this test as specified in EN 60598-2-22.

ILLUMINANCE

The luminous flux density at a surface, i.e. the luminous flux incidence per unit area. The unit of illuminance is lux.

LUMINAIRE

An apparatus, which distributes filters and transforms the lighting provided by lamps and includes all the items necessary for fixing and protecting these lamps and for connecting them to the supply circuit. Note that internally illuminated signs are a special type of luminaire.

MAINTAINED EMERGENCY LUMINAIRE

A luminaire containing one or more lamps all of which operate from the normal supply or from the emergency supply at all material times.

MOUNTING HEIGHT

The vertical distance between the luminaire and the working plane. Note that the floor is taken to be the working plane for emergency lighting.

NON-MAINTAINED EMERGENCY LUMINAIRE

A luminaire containing one or more lamps, which operate from the emergency supply only upon failure of the normal mains supply.

NORMAL LIGHTING

All permanently installed artificial lighting operating from the normal electrical supply that in the absence of adequate daylight, is intended for use during the whole time that the premises are occupied.

RATED DURATION

The manufacturer's declared duration, specifying the time for which the emergency lighting will provide the rated lumen output after mains failure. This may be for any reasonable period but is normally one or three hours.

RATED LOAD

The maximum load that may be connected to the system and will be supplied for the rated duration.

RE-CHARGE PERIOD

The time necessary for the batteries to regain sufficient capacity to achieve their rated duration.

RESPONSIBLE PERSON

Are the employer and any other person who may have control of a part of the premises.

SELF-CONTAINED EMERGENCY LUMINAIRE OR SINGLE POINT LUMINAIRE

A luminaire or sign providing maintained or non-maintained emergency lighting in which all the elements such as the battery, the lamp, and the control unit are contained within the housing or within one metre of the housing.

SLAVE OR CENTRALLY SUPPLIED LUMINAIRE

An emergency luminaire without its own batteries designed to work with a central battery system.

Initial Considerations

Emergency lighting is an essential part of the building services installation.

To ensure the system is well designed and as reliable as possible, planning is important through all phases of the project, from considering legal requirements to final commissioning and maintenance. Consultation between all interested parties at an early stage of the design cannot be over emphasised to avoid expensive modifications to the completed system.

Considerable legislation and associated standards exist covering the various types of premises that involve the need to incorporate emergency lighting.

The first stage of system design is to gather the information needed on the project, normally by consultation with the Regulatory Authority and the user. This should cover legislative and likely operational requirements, and customer preferences.

Legislative Requirements

There is a considerable amount of British and European legislation affecting Emergency Lighting
The major items are:-

The Construction Products Directive (89/106)

Section 4.3.8.1 Defines - Emergency Lighting Installation (panic lighting, escape lighting)

The purpose of the installation is to ensure that lighting is provided promptly, automatically and for a suitable time in a specific area when normal power supply to the lighting fails. The purpose of the installation is to ensure that:-

- The means of escape can be safely and effectively used.
- Activities in particularly hazardous workplaces can be safely terminated.
- Emergency actions can be effectively carried out at appropriate locations in the workplace.

In the UK this is implemented by the *Building Control Officers* and applies to most new and refurbished buildings except for private dwellings.

For England and Wales details of the requirements are given in Part B 1 Section 6.36 of the Building Regulations. This specifies that all escape routes and areas listed in Table 9 should have emergency lighting complying with BS 5266-1.

The 2000 edition has been upgraded to require any open areas larger than 60m² in Shop, Commercial, Industrial, Storage and other non residential premises to have emergency lighting (previously it just applied to offices)

School buildings without natural light or used outside normal hours must now have emergency lighting.

Scotland and Northern Ireland have equivalent legislation and guides.

The Workplace Directive (89/654)

- 4.5 Specific emergency routes and exits must be indicated by signs in accordance with the national regulations.
- 4.7 Emergency routes and exits requiring illumination must be provided with emergency lighting of adequate intensity in case the lighting fails.

In the UK this is implemented by the *Fire Authority* and the new guidance document issued by the Home Office clarifies that this is done by the user performing a risk assessment for all premises in which people are employed.

The Fire precautions act has now been replaced by the **Regulatory Reform (Fire Safety) Order 2005** which supersedes the use of fire certificates for most premises instead employers (or whoever is responsible for the people in the building) will have to produce evidence of compliance to their risk assessment if required by the fire authority who will audit the installation.

If 5 or more people are employed there must be a written record of the assessments findings and the action taken.

If a fire certificate has been issued recently a risk assessment is still required but it is likely that few if any additional fire precautions will be needed.

If the fire certificate was given according to an out-of-date standard this must be addressed in the risk assessment.

The Signs Directive (90/664) implemented in UK by Statutory Instrument 341

6. Depending on requirements, signs and signalling devices must be regularly cleaned, maintained, checked, repaired, and replaced.
8. Signs requiring some form of power must be provided with a guaranteed supply.

In the UK the Health and Safety Executive have passed responsibility for ensuring compliance to the Fire Authority, they have produced a combined guidance document covering the use of safety signs.

Other UK Legislative Requirements

Some workplaces require a licence from the Local Authority. The Fire Authority may require higher levels for premises including:-

- Sale of alcohol
- Sports stadia
- Music and dancing
- Theatres and cinemas
- Gambling
- Public entertainment

Some premises must be registered with the Local Authority

They also need to be accepted by the Fire Authority including:-

- Nursing Homes
- Residential care homes
- Children's homes
- Independent schools

Essential Pre-Design Information

Before designing an emergency lighting scheme the following information needs to be determined from the site drawings or from the specifier:-

- The duration of the emergency lighting:

Three hour duration is required in places of entertainment and for sleeping risk.
Three hour duration is required if evacuation is not immediate, or early re-occupation is may occur.
One hour duration may be acceptable, in some premises, if evacuation is immediate and re-occupation is delayed until the system has recharged.
- Emergency lighting of the maintained type should be used in areas in which the normal lighting can be dimmed and in common areas within where a build-up of smoke could reduce the effectiveness of normal lighting. Maintained lighting which combines both emergency and normal lighting functions may also be desirable for aesthetic or economic reasons.
- The exit signs always need to be illuminated to be visible at all times when the premises are occupied. Because of the difficulties of ensuring that the normal lighting will adequately do this maintained signs are required in licensed and entertainment venues and they should be used in any premises which are used by people who are unfamiliar with its layout.
- Building plans need to be obtained showing the location of the fire alarm call point positions, the positions of fire fighting equipment, and fire and safety signs.
- Emergency escape routes should be established, and potential hazards investigated.
- Open areas larger than 60m² floor area or areas identified by the risk assessment as requiring lighting.
- High risk task areas should be identified and normal lighting levels established.
- Determine the need for external illumination outside final exit doors and on a route to a place of safety.
- Other areas that need illumination, although not part of the escape route, should be located, e.g. lifts, moving stairways and walkways, plant rooms and toilet accommodation over 8m² gross area.
- For central systems, a low fire risk location for the battery units and cable runs should be established.

- For non-maintained applications the area covered by the final circuit of the normal lighting has to be determined, as self-contained luminaires must be fed from that final circuit and it must be monitored by the central system.
- Standby lighting requirements should be established, if activities need to continue during a failure of the normal lighting supply.
- The customer's preference and operating considerations should be ascertained,
- Appropriate testing systems and maintenance procedures must be determined
- Any hazards identified by the risk assessment must be covered.

Design of New Installations

System design to meet BS 5266 Pt 1: 2005 and requirements of European and draft European standards.

Design Objective

When the supply to any part of the normal lighting fails, the requirements of BS 5266 and EN 1838 apply and escape lighting is required to fulfil the following functions:-

- (I) Show clearly and unambiguously the escape routes.
- (II) Provide illumination along such routes to allow safe movement towards and through the exits.
- (III) Ensure that fire alarm call points and fire fighting equipment provided along escape routes can be readily located.
- (IV) Allow operations concerned with safety measures to continue.

Stage 1 - Design Procedure

Locate luminaires at points of emphasis. These are mandatory locations to cover specific hazards and to highlight safety equipment and signs. The luminaires act as beacons over parts of the escape route that may be dangerous at low levels of illumination and also highlight other safety equipment that may need to be operated.

This procedure should be performed regardless of what part of the building is considered and whether the area is an emergency escape route or defined as an open area.

Only when this is accomplished should the type of luminaire or its light output be considered.

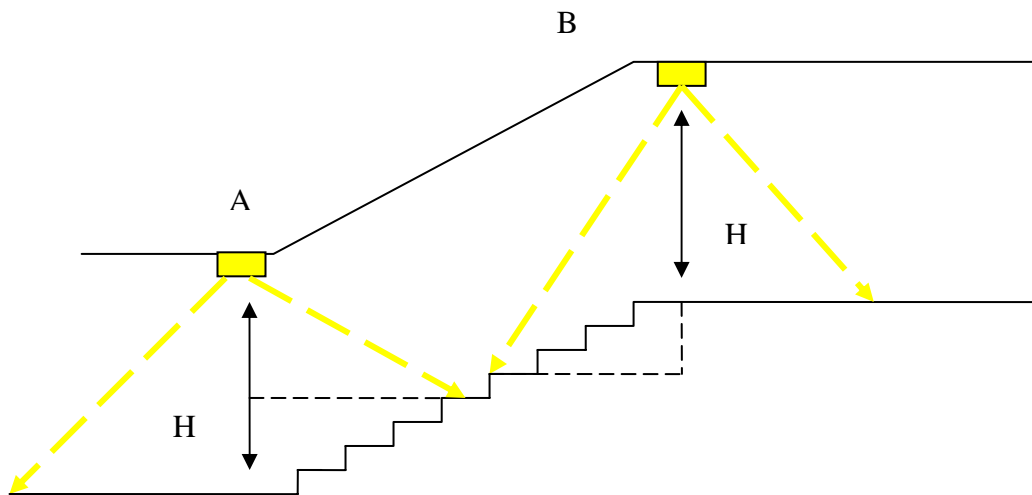

Near Stairs or any other Change of Level

The luminaires must be located so each tread receives direct light.

Generally at least two luminaires will be needed to provide the 1 lux minimum level on the centre of each tread (even old designs to 0.2 lux needed the higher level on the treads unless contrasting colour stair nosings were fitted)

The spacing from luminaire A is reduced as the height being reduced as the points illuminated rise up the stairs so the cosine correction factor reduces the light.

The spacing from fitting B may be reduced as although the cosine correction improves in comparison with the floor level as the treads descend at some point the effect of increased distance from the luminaire will outweigh this.

Other changes of level that can cause tripping hazards at low light levels must also be illuminated

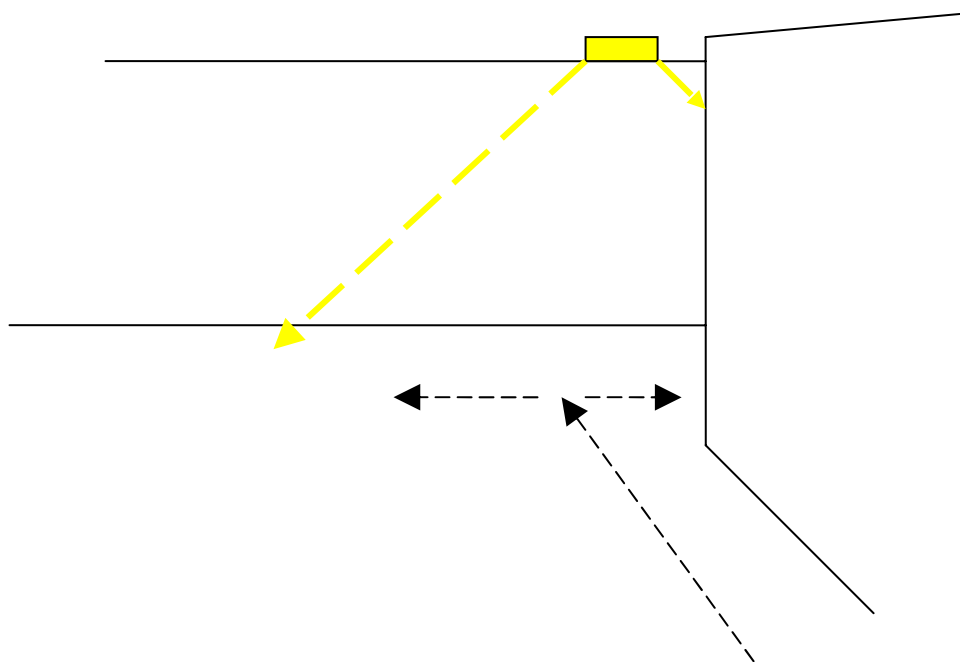

Near Changes of Direction and Intersections of Corridors

At any position that the escape route changes direction or if it intersects a corridor the luminaires act as beacons to indicate the route and also provide the most illumination where two streams of escaping occupants could be joining.

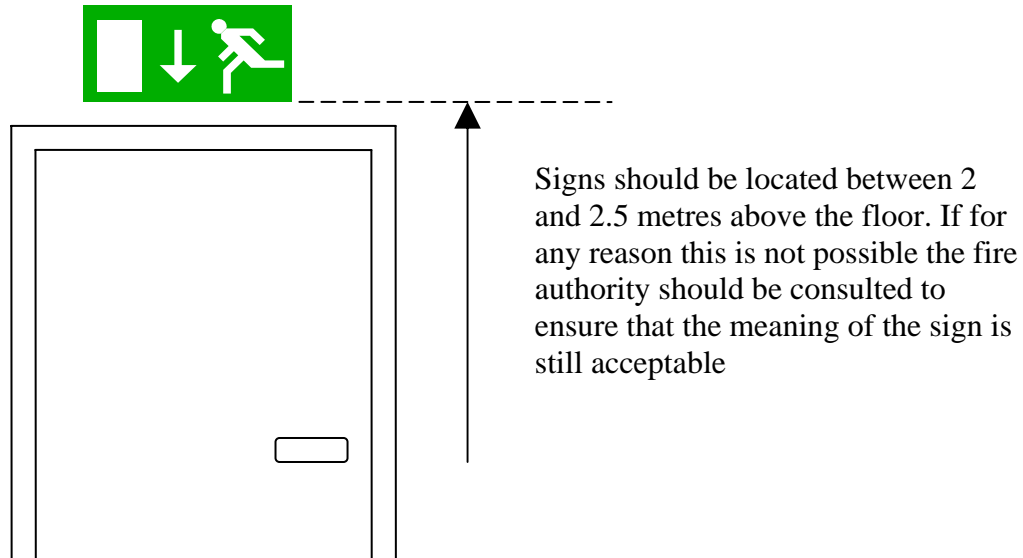

Illuminate Exit and other Safety Signs

While this normally relates to exit direction and first aid signs the risk assessment may indicate that other safety signs such as a radioactive warning also need emergency illumination. Exit signs should not be used in the photometric calculations unless their characteristic has been tested and authenticated data is available.

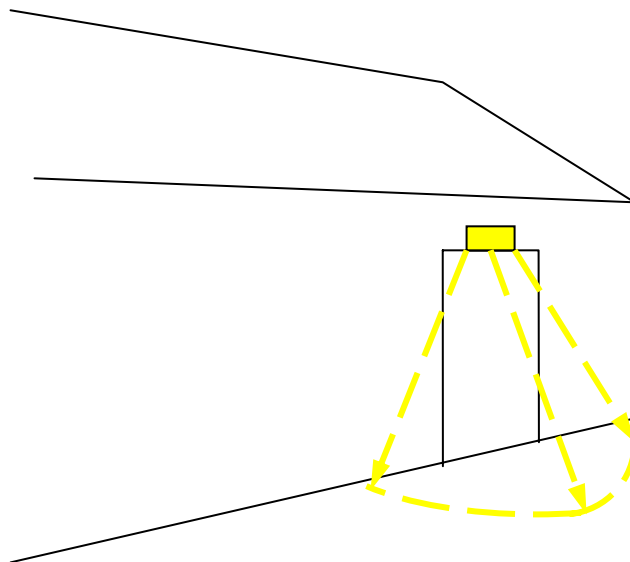

Outside and Near to Exits

The safety of occupants must be protected until they are away from the influence of the building. If the area outside the building has hazards in darkness such as a river bank the risk assessment should determine if further emergency luminaires are needed till a place of safety can be reached. If street lighting is available and adequate it may be used with the agreement of the fire authority.

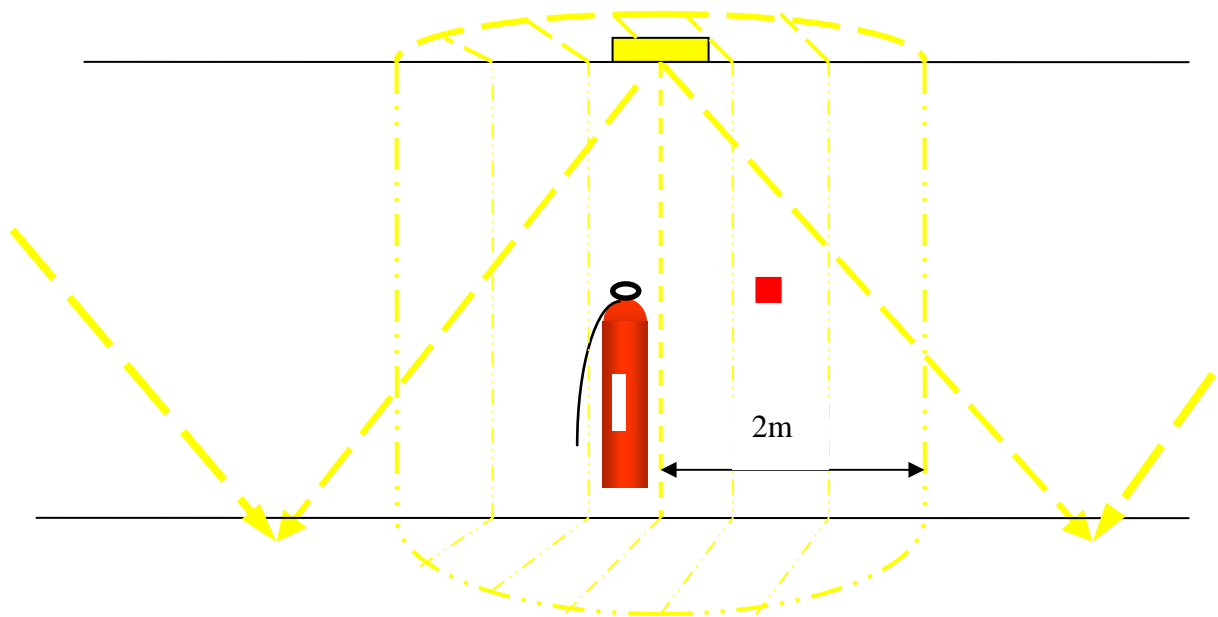

Near Fire Fighting Equipment and Call Points

The luminaire must be sited within 2 metres (measured horizontally) of any extinguishers, hose reels, fire alarm control or repeater panels and fire call points. The chain shaded parts of the diagram show the positions that the luminaire covers for this purpose.

By locating the luminaire in proximity to the fire safety equipment it acts as a beacon directing the eye to the safety equipment. It also ensures that the fire equipment which may have instruction on it for its safe use is gets the maximum illumination by being under the luminaire.

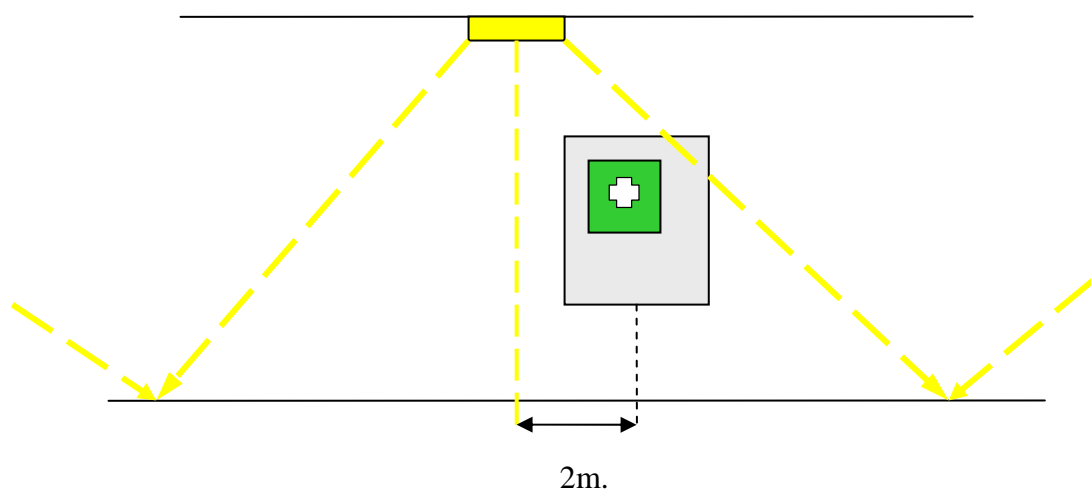

Near First Aid Post

This category was introduced in the 1999 edition of BS 5266-1 and recognises that if the normal lighting supply fails but there is no fire requiring immediate evacuation then access to and use of other safety equipment must be maintained.

Stage 2 - The Location and illumination of Exit Signs

Section 5.6 of BS 5266 and EN 1838 state that:-

“Signs are required at all exits, emergency exits and escape routes, such that the position of any exit or route to it is easily recognised and followed in an emergency. Where direct sight of an exit or emergency exit is not possible and doubt may exist as to its position, a directional sign (or series of signs) should be provided, placed such that a person moving towards it will be progressed towards an exit or emergency exit”.

The Format of Signs

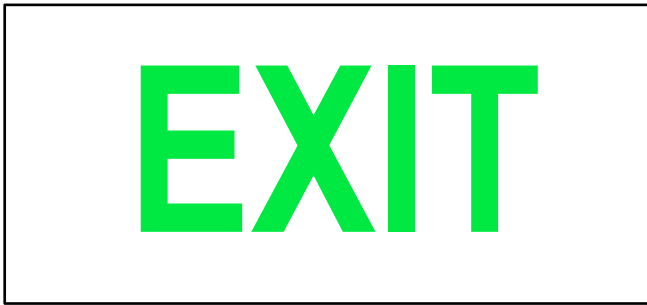

BS 2560

Old format of sign green words only out of a white background

These signs should all have been replaced by the 24th of December 1998 but some are still in existence



BS 5499 -1 format has the addition of a running man pictogram and was an interim move towards the full pictogram sign is acceptable on existing buildings provided the meaning is still clear

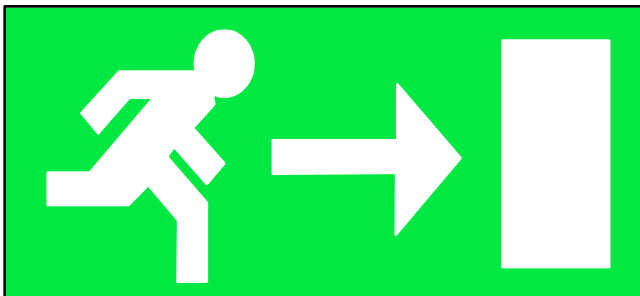

Signs Directive Format

The European and British legislative format with a full pictogram only sign its use is defined in the HSE guidance document

The following advice is based on the Health and Safety Executive guidance on the Regulations (L64):

BS 2560 SIGNS

These signs should have been replaced by 24 December 1998. ICEL recommends that care should be taken as the new pictogram formats with larger areas of green colour will significantly reduce luminaire light output and installations may require additional emergency illumination to compensate.

BS 5499: PT 1: 1990

These signs - already installed - are of a similar pattern to the Signs Directive and are considered to comply with the regulations and do not need to be replaced.

SIGNS DIRECTIVE

Implemented as a legal requirement in the UK by Statutory Instrument 1996 No. 341 on 1 April 1996.

Application Requirements

The guidance to the Fire Safety Order accepts either running man format but requires that they should not be mixed in a building

Exit and safety sign - Maximum Viewing Distances

Viewing distances are given in EN 1838 as $200 \times H$ for internally illuminated signs, and $100 \times H$ for externally illuminated signs where H is the height of the pictogram.

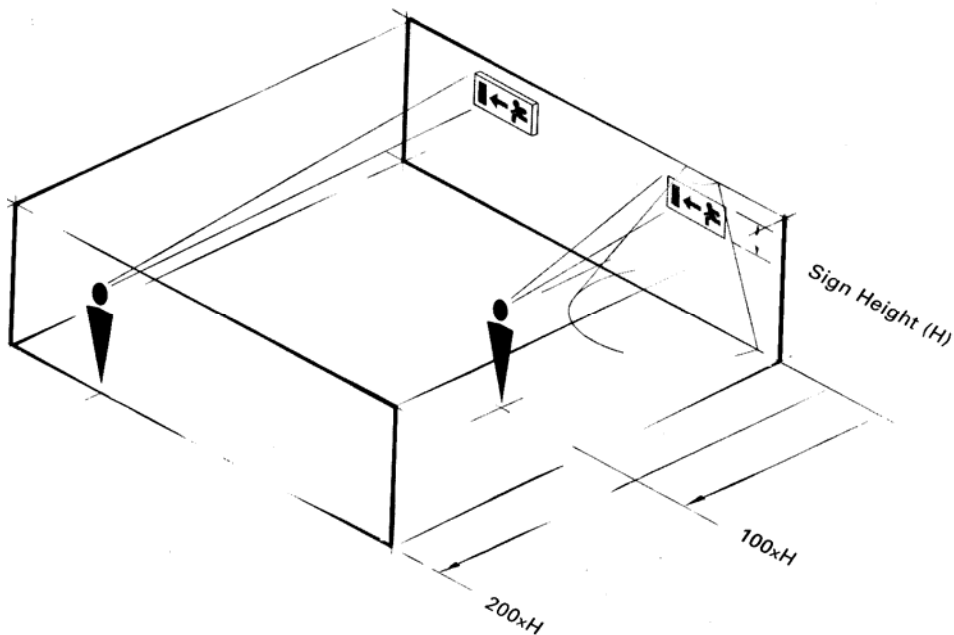

Illumination Requirements for Safety Signs

EN 1838 section 5 also details the illumination conditions for a sign to be clearly visible for the distances specified above. These values are checked by BSI and ICEL registration for internally (self) illuminated signs but if the sign is not approved or is externally illuminated the following values must be achieved

The colours must conform to ISO 3864 (white figures with green background for Exit and first aid signs)

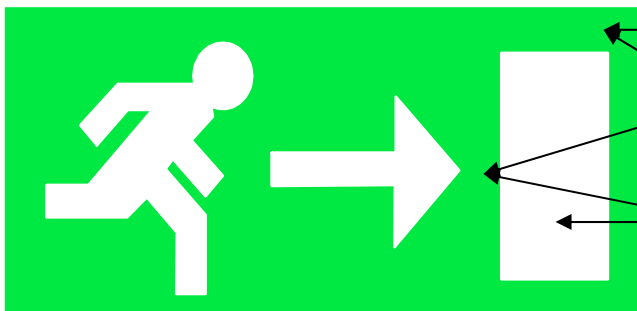

- Minimum luminance of any part of the signboard 2 cd/m^2
- The ratio of maximum to minimum luminance of any area of either colour of the sign shall not be greater than 10:1
- The ratio of luminance between white and the colour shall be between 5:1 and 10:1

Note: The English and Welsh guides to fire safety risk assessments give advice that exit signs should be illuminated and that Photoluminescent signs should not be used where other forms of illumination are present.

Stage 3 - Additional Emergency Lighting

Additional emergency lighting should be provided at these locations:

- (I) Lift cars. Although they may be part of the escape route in exceptional circumstances, they may present a problem if the public are trapped in them in the event of a supply failure.
- (II) Toilet facilities and other similar areas exceeding 8m² floor area or with no borrowed light and all toilets for the disabled.
- (III) Escalators, to enable users to get off them safely.
- (IV) Motor generator, control or plant rooms require battery supplied emergency lighting to help any maintenance or operating personnel.
- (V) Covered car parks along the normal pedestrian routes.

Stage 4 - Illuminance Requirements for Escape Routes

In addition to luminaires at the points of emphasis, it may be necessary to provide extra luminaires to ensure that minimum light (illuminance) levels are met along the whole escape route. For 2m wide escape routes, the illuminance is specified along the centre line with 50% of that illuminance over the 1 metre wide central band. Wider routes should be treated as open areas or as multiple routes.

Illuminance Requirements

The European standard EN 1838 requires 1 lux along the centre line of escape routes including those with minor obstructions such as hotel trolleys. The UK has a National Exception, which recommends 1 lux but accepts 0.2 lux along the centre line for permanently unobstructed escape routes, with the points of emphasis illuminated to 1 lux. BS 5266: Pt 1: 1988 has been amended to reflect this requirement.

BS 5266 and EN 50172 recommend using a larger number of low power luminaires rather than a few high power units. Each compartment of the escape route should be lit by at least two luminaires thus, if a luminaire fails, the route will not be plunged into darkness.

Spacing Tables

Authenticated spacing tables provide the information to help you decide whether or not additional fittings are needed besides those required for the points of emphasis. ICEL registered luminaires have been independently tested to prove their photometric performance and the tables generated have been third party inspected.

BSI or an equivalent test house have to produce photometric tests on approved luminaires giving the lighting distribution round the fitting and the initial and end of life total light outputs from this data the manufacturers construct tables to allow easy design for installers. The accuracy of the tables is independently verified by ICEL.

The tables show the distance from the wall or door to the first fitting and then the distance that must not be exceeded for spacing between subsequent fittings. This is shown for the fittings being mounted either parallel to the route (axial) or at right angles to the route (Transverse) for different mounting heights. In addition to values for escape routes figures are also given for the coverage of open areas by regular arrays of luminaires

SPACING TABLE FOR TYPICAL LUMINAIRE

Ceiling Mounting Height m.	Escape Routes 1 lux minimum along centre line				Open areas 0.5 Lux minimum in central core			
	Transverse to wall	Transverse to transverse	Axial to Axial	Axial to wall	Transverse to wall	Transverse to transverse	Axial to Axial	Axial to wall
2.5	2.7	7.2	4.6	1.5	2.5	8.5	7.4	2.3
4	2.1	7.5	4.8	1.7	2.6	9.8	8.6	2.3
6	-	5.3	3.7	-	1.8	10.3	9.5	1.6

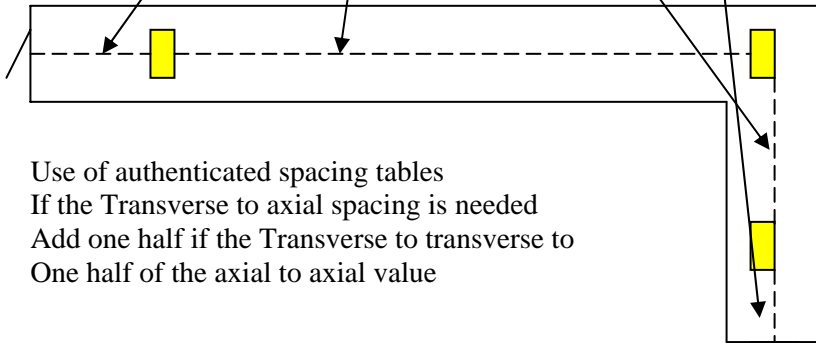

Use of authenticated spacing tables
 If the Transverse to axial spacing is needed
 Add one half if the Transverse to transverse to
 One half of the axial to axial value

ESCAPE ROUTES – BS EN 1838 Requirements

4.2.1 For escape routes up to 2m in width, the horizontal illuminances on the floor along the centre line of an escape route shall not be less than **1 lux** and the central band consisting of not less than half of the width of the route shall be illuminated to a minimum of 50% of that value.

Note: The UK has an A Deviation which recommends the above because it is not possible to be sure in advance if either initially or during the evacuation an escape route will be obstructed. However

If it is certain that the route will be permanently unobstructed the old level of 0.2 lux can be used for escape routes except for stairs and changes of level which must be to 1 Lux.

Verified values are given in ICEL 1001 as authenticated data that has been derived from BSI test data de-rated for the end of Battery and lamp design life with allowance for the effects of dirt and ignoring reflection.

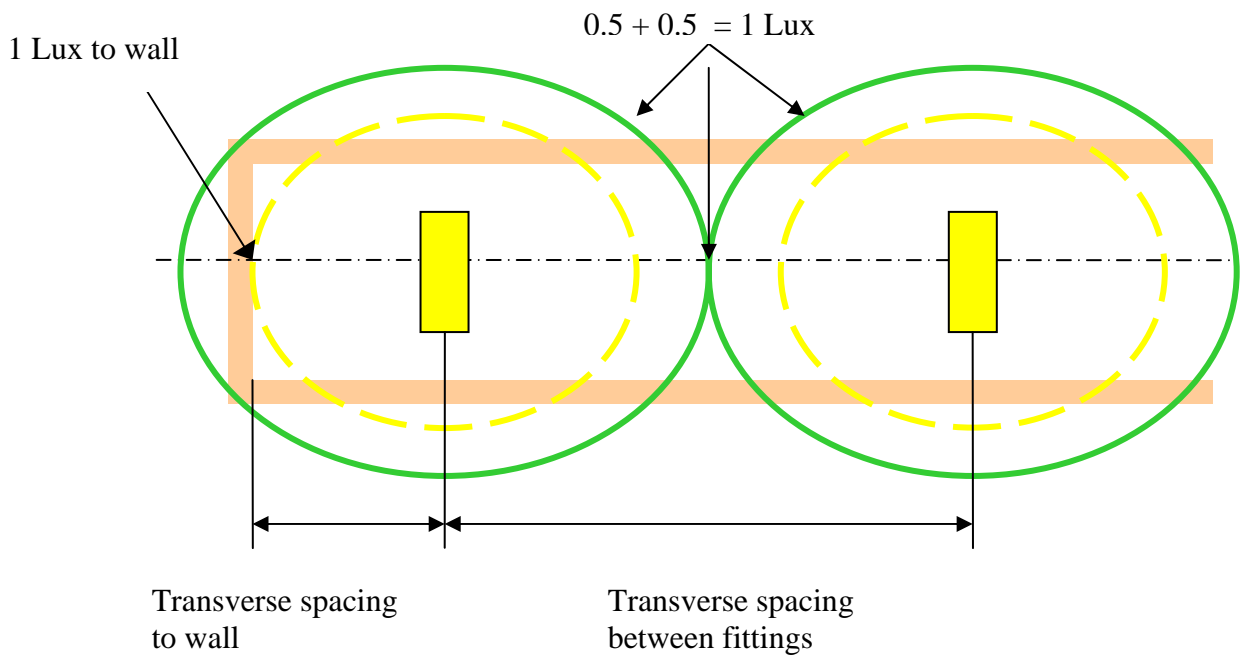

Stage 5 - Illuminance Levels for Open Areas

Emergency lighting is required for:-

- Open areas larger than 60m²
- Areas of any size with an escape route passing through them.
- Any areas that the risk assessment has identified as requiring emergency illumination for example such as a school chemistry laboratory where students handling acids would be at risk if plunged into darkness

OPEN AREAS – BS EN 1838 Requirements

The standard BS EN 1838 (BS 5266-7) requires 0.5 lux minimum anywhere in the central core of the floor area. This core area excludes the 0.5m to the perimeter of the area.

The shadowing effects of movable objects in the core area are all so excluded.

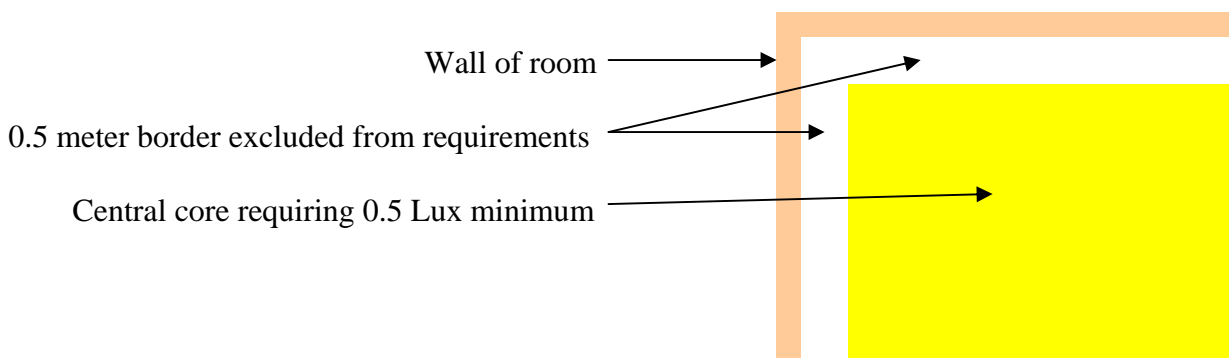

Spacing Tables (See stage 4) provide simple and accurate data for the design of open areas. They assume a regular layout and give the distances from wall and between fittings

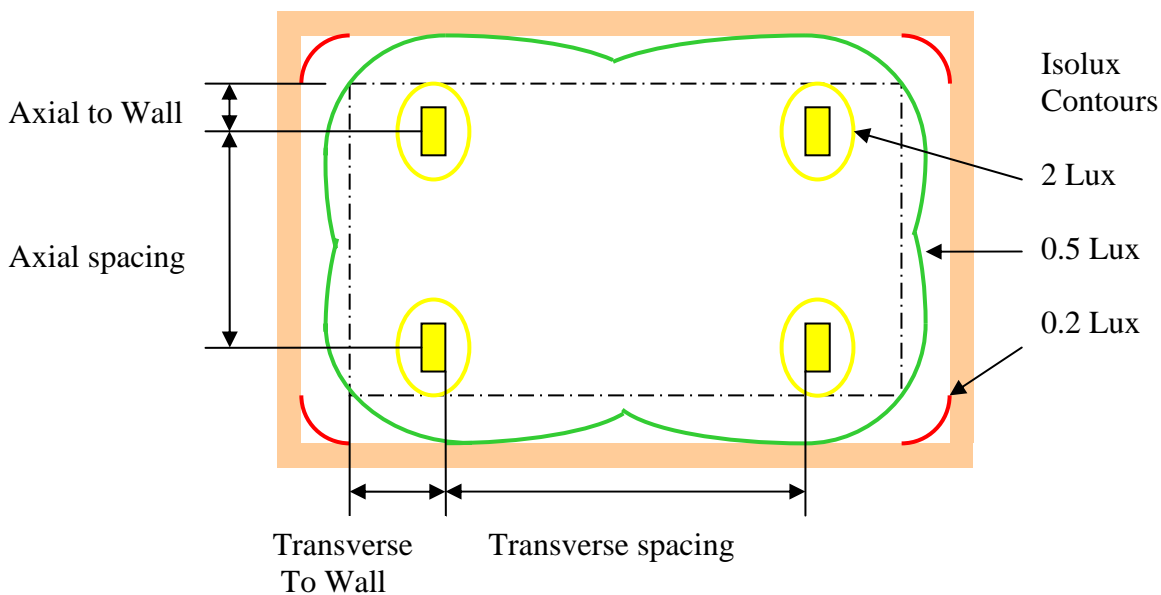

Use of ICEL Authenticated Spacing Tables to Design Open Areas to 0.5 Lux

Open areas 0.5 Lux minimum in central core

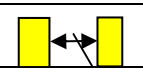
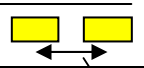
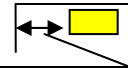
Transverse to wall	Transverse to transverse	Axial to Axial	Axial to wall
			
2.5	8.5	7.4	2.3

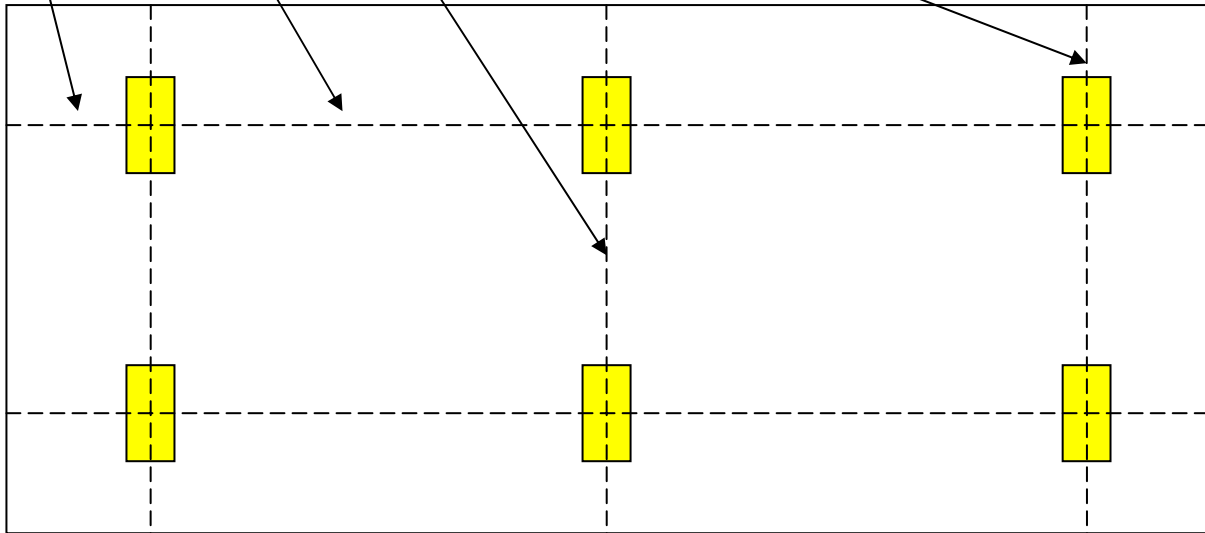

Summary of Changes to Illuminance Requirements

	CURRENT – BS EN 1838 /BS 5266-7 1999	OLD - BS 5266: Pt 1: 1988
Escape routes	1 lux minimum <i>There is a UK national Exception allowing 0.2 lux in permanently unobstructed escape routes. Due to the possible difficulties in keeping escape routes permanently unobstructed, ICEL recommends that the 1 lux minimum from EN 1838 is used.</i>	0.2 lux minimum <i>Higher levels are required for routes with obstructions or used by older people but the lighting level is not defined.</i>
Open areas	<i>0.5 lux minimum in core area</i>	<i>1 lux average over total area</i>
Additional areas (e.g. lifts, escalators)	<i>0.5 lux minimum</i>	<i>not specified</i>
High risk task areas	<i>10% of normal illuminance</i>	<i>not specified</i>

All values are designed with zero reflectance.

ICEL recommends that specifiers check that spacing tables are available and that manufacturers prove authenticated photometric data as available from the ICEL Registration Scheme. ICEL offers a scheme of product registration to provide assurance to the user that those products have been

previously certified to the appropriate National and International Standards, that the manufacture of the product is carried out in a facility operating a recognised scheme of quality assurance, and that performance claims made for the product are valid.

Stage 6 - High Risk Task Area Lighting

BS 5266 requires that higher levels of emergency lighting are provided in areas of particular risk, although no values are defined.

The European standard EN 1838 says that the average horizontal illuminance on the reference plane (note that this is not necessarily the floor) should be as high as the task demands in areas of high risk. It should not be less than 10% of the normal illuminance, or 15 lux, whichever is the greater. It should be provided within 0.5 seconds and continue for as long as the hazard exists. This can normally only be achieved by a tungsten or a permanently illuminated maintained fluorescent lamp source.

The required illuminance can often be achieved by careful location of emergency luminaires at the hazard and may not require additional fittings.

Stage 7 - Choice of Appropriate Emergency Lighting Systems

DURATION

See earlier section on Essential Pre-Design Information.

TYPE OF SYSTEM

The type of system used depends on the size and function of the premises. See section 9 of BS 5266: Pt 1: 2005

Stage 8 - Design Control Procedures

The illuminance of the installation depends as much on the light distribution as it does on the light output available from the chosen luminaire. Consequently, luminaire types specified for a particular design must not be changed without a re-appraisal of the photometric design.

Testing and Log Book

The system should include adequate facilities for testing and recording the system condition. These need to be appropriate for the specific site. It might be feasible to perform a full discharge test of the installation in an office block by isolating the total supply. This would be inappropriate and potentially dangerous, in a hotel occupied 24 hours a day.

A test system able to operate alternate fittings would be more suitable to eliminate the risk of having all the luminaires discharged while the building is occupied.

The Old BS 5266-1 1999 Test Regime called for:-

A function test for a short period once a month to check that the luminaire is working.

A discharge duration test -when self contained fittings are new this test is for one third of there rated capacity every six months (this hopefully retains some battery capacity if immediately after the test there is a mains failure) After the fittings are three years old and approaching their four year minimum design battery life the test should be done annually for the full rated duration.

BS 5266-1 2005 Aligns with the Testing Shown in BS EN 50172/BS 5266 pt 8

A function test for a short period once a month to check that the luminaire is working.

A discharge duration test –**Annually** for full rated discharge.

Note: The risks that any tests will materially discharge the battery must be minimised either by ensuring the building will be empty during test and recharge or alternate fittings should be tested.

Automatic Testing Systems

HD 62034. Details requirements to automatically test emergency lighting to the schedules in EN 50172, consist of the following major forms:

1. **Individually controlled self contained luminaires** which have built in timing, testing and indication functions these can be set to provide the test annually either all luminaires operating simultaneously if it is known that the premises will be empty or with alternate interleaved luminaires at least 24 hours apart so that in premises that may be occupied during test or recharge no compartments will be in totally reliant on the luminaires under test.

These systems require inspection and recording of test indication after each monthly test.

2. **Self contained luminaires controlled by a panel** and giving indication through that panel these systems are normally provided with a number of test circuits which can be used to ensure 24 hour timing separation if needed.

These systems normally collate test results at the panel and often can diagnose any faults found they may also be provided with automatic print out.

3. **Central battery systems from a panel** these systems control the test and check the operation of the slave luminaires. If they are used in installations that may be occupied they must either have dual battery systems supply interleaved luminaires, have facilities to manually initiate the test at safe times or to conduct a shorter discharge while checking the battery voltage to a higher limit than for the full discharge'

Commissioning Certificate

The model Commissioning Certificate as shown in BS 5266: Pt 1: 1999 requires written declaration of compliance to be available on site for inspection.

These consist of:-

- (I) Installation quality. The wiring installation must conform to the wiring regulations HD 384, and suitable cable, with adequate support and protection, must be used.
- (II) Photometric performance. Evidence of compliance to the design criteria has to be obtained. ICEL 1001 registered fittings are photometrically tested and their spacing data is registered by the ICEL scheme. Copies of this data provide the verification required so long as the spacing is not exceeded.

- (III) A declaration of a satisfactory test of operation and compliance to BS 5266.
- (IV) A log book should be kept readily available for inspection. It should record the date and brief details of completion, any alterations, periodic inspections and test certificates, each service, inspection or test carried out, defects and remedial action.

Stage 9 - Maintenance

Essential servicing should be defined to ensure that the system remains at full operational status. This would normally be performed as part of the testing routine, but for consumable items, such as replacement lamps, spares should be provided for immediate use.

Checklist for Assessing an Existing Installation

Records

- Are the entries made in the log book correct?
- Are up-to-date drawings available and correct?
- Are routine tests completed according to the requirements in BS 5266?

Emergency Luminaires and Escape Route Signs

- Are the fittings supplied with the correct operating voltage?
- Are the fittings cleaned and sited in their correct operating environment, e.g. for temperature and IP rating?
- Do the luminaires operated in the correct mode, e.g. maintained for sleeping accommodation?
- Do the luminaires operate for the required emergency duration?
- Are there signs that clearly show the emergency escape route from any position within the premises?
- Are all exits marked and directions of travel indicated?
- Are the signs illuminated internally or from an external source when the normal lighting supply fails?
- Is the size of each sign correct for the viewing distances?
- Do the sign legends comply with the Health and Safety (Safety Signs and Signals) Regulations. S.I. No. 341, 1996?

Siting of Luminaires

- Are the luminaires positioned at all points of emphasis?
- Are the luminaires positioned along the escape routes at the correct spacing to ensure that the required illuminance levels are achieved? The ICEL mark is the best means of assuring that the luminaires meet the photometric performance claims.
- Are the luminaires positioned in open areas (anti-panic areas) at the correct spacing to ensure that the minimum illuminance level is achieved?
- Are the non-maintained luminaires fed from the same final circuits as the local lighting?
- Are there at least two luminaires in each “lighting compartment” to ensure that the area is not plunged into darkness if a luminaire fails?
- Are additional luminaires provided in lift cars, escalators, toilets, etc?
- Are hazardous areas illuminated at 10% of normal illuminance?

Central Battery Systems

- Does the central battery system comply with EN 50171 and HD 384?
- Is the battery charger functioning?
- Where applicable, are the battery electrolyte levels and specific gravities satisfactory?

Self-contained Emergency Luminaires and Signs

- Are the batteries being charged (LED – on)?
- Are the luminaires marked ICEL to show compliance with all relevant product standards for escape routes?

Relevant Standards

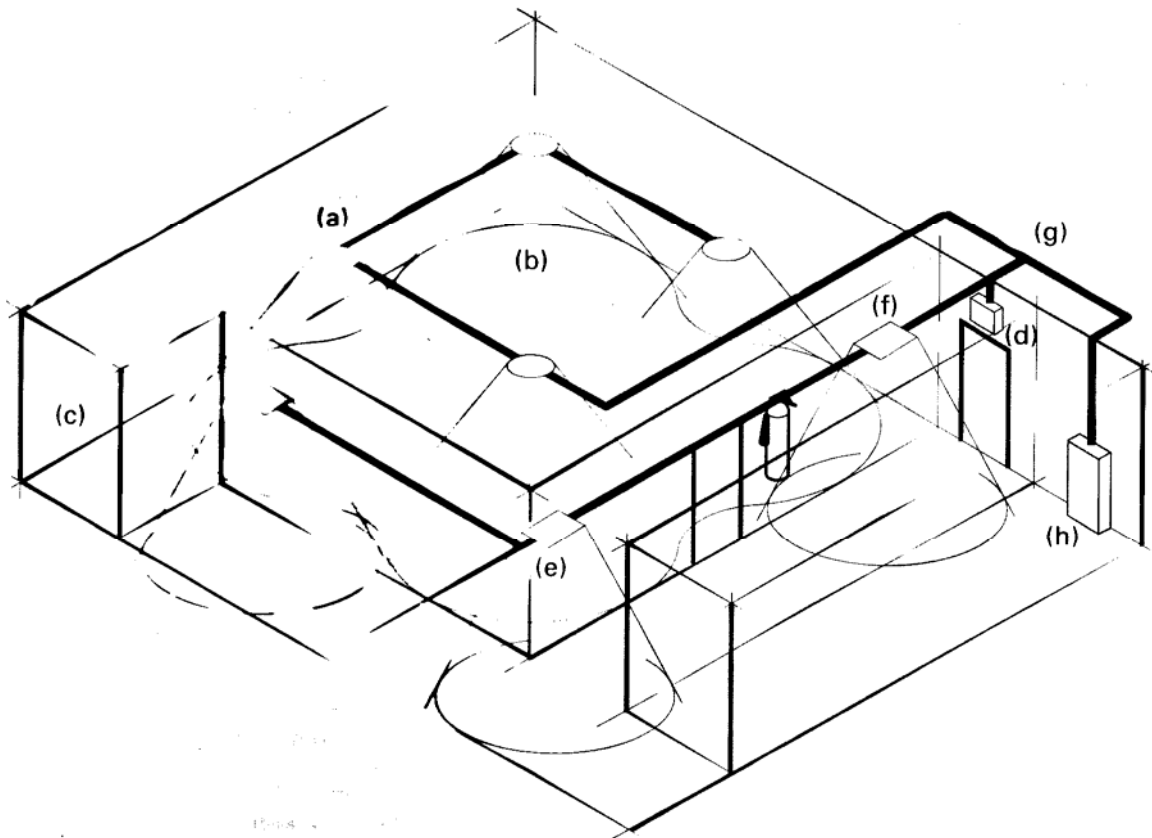

- a EN 60598-2-22 Luminaire product standard
- b Open area lighting EN1838
- c Other areas EN 1838
- d Signage
- e Duration and mode of operation BS 5266-1
- f Escape route lighting EN 1838
- g Wiring HD 384
- h Central system EN 50172
- i Automatic test system EN 62034

Legislation & Standards Affecting Emergency Lighting

UK Legislation

Regulatory Reform Fire Safety Order 2005

(Replaces - Fire Precautions Act 1971)

The Building Regulations 1991

The Cinematograph Act 1952

Cinematograph (Safety) Regulations Statutory Instrument 1955 No. 1129

Health and Safety (Safety Signs and Signals) Regulations 1996: Statutory Instrument No. 341

Other legislation dealing with premises licensed or registered for public assembly or residential purposes, e.g. Licensing Act, Local Government (Miscellaneous Provisions) Act, Theatres Act, and Residential Homes Act etc, the guides for which all contain a requirement for emergency lighting.

British Standards: General Series and Codes of Practice

BS 5266: Pt 1: 2005 Code of Practice for the emergency lighting of premises other than cinemas and certain other specified premises used for entertainment.

CP 1007: 1955 Maintained lighting for cinemas (replaced by BS 5266-1 2005)

BS EN 60598-2-22: 1998 Specification for luminaires for emergency lighting

BS 5499: Pt 1: 1990 (1955) Specification for self-luminous fire safety signs

BS 5499: Pt 3: 1990 Specification for internally-illuminated fire safety signs.

BS EN 50171 1999 centrally powered systems

British and Harmonised European Standards

Electrical installation of buildings HD 384 Chapter 56

Specification for luminaires for emergency lighting EN 60598-2-22:

Lighting applications – emergency lighting EN 1838

Central power supply systems EN 50171

Emergency escape lighting systems EN 50172

Measurement and presentation of photometric data for lamps and luminaires EN 13032-3

European Directives and Recommendations

Workplace Directive (89/654 EEC)

Construction Products Directive (89/106 EEC)

Safety Signs Directive (92/58 EEC)

Fire Safety in Hotels Recommendation - Requirements for Europe (86/666 EEC)

The Workplace Directive is partially implemented in the UK by The Workplace (Health, Safety & Welfare) Regulations 1992. It includes within its scope of premises most buildings where people are employed.

The Workplace Regulations apply to every workplace with certain exceptions such as ships, construction sites, mines, temporary workplaces, fields, woods or other agricultural or forestry land, aircraft, locomotive or rolling stock, trailers and some vehicles. The Regulations require a risk assessment and an emergency plan to be prepared. The supporting guidance stresses the need for cost benefit analysis and minimising burdens commensurate with saving lives and the safe evacuation of premises.

The Workplace Directive is retrospective, i.e. it requires that, over time, all places of work (with the above exemptions) are brought up to standard.

In the England and Wales this is now being implemented by the Regulatory Reform (Fire Safety) Order

11 Guidance documents are being issued to cover specific applications.
Scotland and Northern Ireland have equivalent legislation and guides.

The Construction Products Directive covers both buildings and civil engineering works including domestic, commercial industrial, agricultural, educational and recreational buildings as well as roads and highways, bridges, docks and tunnels. It requires that such buildings or works are designed and built in such a way that they do not present unacceptable risks of accidents in service or in operation such as stumbling or tripping in poor visibility, and that the safety of occupants and rescue workers is ensured in the case of fire. Minimum standards of illumination are required so that people may move safely within the works, including if they have to escape. In addition, escape routes are required to provide secure and adequate lighting, capable of operating despite failure of the electrical supply.

The Safety Signs Directive is retrospective and was implemented in the UK on 1 April 1996. It calls for the provision of emergency signs in all places of work. These signs must be regularly cleaned, tested and maintained, and visible at all times. The traditional text EXIT signs must have been replaced by the pictogram by December 1998. A guide to Statutory Instrument No. 341, The Health and Safety (Safety Signs and Signals) Regulations 1996, has been published by the Health and Safety Executive - No. L64.

Note: the latest edition of documents (Directives, standards, guidance notes etc) should be referred to.

Confidence in ICEL

The Industry Committee for Emergency Lighting formulates and promotes standards for emergency lighting and provides guidance to specifiers, users and contractors. ICEL's aim is to direct users to products of assured reliability, quality and photometric performance that help to preserve life in an emergency. The guides and standards published by ICEL since 1978 have become well known and respected world-wide, and have formed the basis of many European standards.

How ICEL Standards have Formed the Basis of European Standards:

ICEL 1001: Pt 1:1985 Construction and performance of equipment for central systems	EN 50171 Central power supply systems
ICEL 1001: Pt 2:1986 Construction and performance of self-contained emergency lighting luminaires	EN 60598-2-22:1998 Specification for luminaires for emergency lighting
ICEL 1002:1980 The photometry of battery operated emergency lighting luminaires	EN 13032-3 Measurement and presentation of photometric data for lamps and luminaires
ICEL 1003:1982 Emergency lighting applications guide	EN 50172 Emergency escape lighting systems
ICEL 1004:1996 The use, or modification, of mains luminaires for emergency lighting applications	No corresponding European standard
ICEL 1005:1988 Operator initiated test devices for emergency lighting luminaires	EN 62034 Emergency escape lighting -Test Systems

ICEL 1006: EMERGENCY LIGHTING DESIGN GUIDE – FEBRUARY 2008

Emergency Lighting - A Life Saving Product

Emergency lighting luminaires and modules can help to save lives. They should be constructed in accordance with appropriate standards, assembled in a factory employing recognised and suitable quality assurance procedures, and correctly installed in accordance with correct performance data. ICEL offers a scheme of product registration to provide assurance to the user that those products have previously been certified to the appropriate National and International Standards, that the manufacture of the product is carried out in a facility operating a recognised scheme of quality assurance, and that performance claims made for the product are valid. Products registered under the ICE 1001 Scheme may be marked with the ICEL product registration mark:



ICEL Product Registration Scheme

Reputable manufacturers of self-contained emergency lighting luminaires, from any country, can register products through ICEL and be allowed to use the ICEL product registration mark on these products, if they meet the stringent requirements of the scheme.

National and International Standards

ICEL registered products must have been satisfactorily tested and certified to the harmonised European standard EN 60598-2-22 or national equivalents. Certification must have been granted through a national testing body or acceptable equivalent. The scheme of quality assurance in the manufacturing facility must be in accordance with European standard EN 29000 (ISO 9000) or national equivalent and the manufacturing facility must be assessed and its systems found to be in compliance and accredited as such.

Verification of Photometric Performance Claims

ICEL has devised a photometric performance verification procedure. This procedure describes the test methods that will be employed to validate the claims made by the manufacturer, and describes the manner in which data should be presented to the user of the product. It also describes to the user how the photometric data presented should be used to calculate luminaire spacing and positioning or the result of using a module in luminaire housing. This will ensure correct installation and achieve the required illuminance in accordance with specified requirements.

ICEL

Details of the ICEL Product Registration Scheme, the photometric verification, the product registration mark and the lists of products registered, and a current list of ICEL members may be obtained from the ICEL web site (www.icel.co.uk) or from the following address:

Industry Committee for Emergency Lighting
e-mail: info@icel.co.uk

Appendix

- A Typical Completion certificates to demonstrate compliance with BS 5266-1
- B Compliance checklist for inspection engineers

BS 5266 Pt.1 - EMERGENCY LIGHTING SYSTEMS

EMERGENCY LIGHTING MODEL COMPLETION CERTIFICATE

New Installations and Verification of Existing Installations

Occupier/owner

Address of premises

Declaration of Conformity

In consequence of acceptance of the appended declarations, I/We** hereby declare that the emergency lighting system installed, or part thereof, at the above conforms, to the best of my/our** knowledge and belief to the appropriate recommendations and requirements of BS5266 -1: 1999 'Emergency Lighting - Part 1: Code of Practice for the emergency lighting of premises other than cinemas and certain other specified premises used for entertainment' and BS EN1838 / BS5266 7:1999 'Lighting Applications - Emergency Lighting' except as stated below/overleaf. Also that the installed system will be maintained and tested in accordance with the appropriate recommendations and requirements of BS5266.

Signature of person accepting the system declarations and accepting the qualification of the enterprise making those declarations, on behalf of the above.

.....Name

Note: Signatories are reminded of their obligation to show due diligence through verification of the validity of declarations and the appropriate qualification of those making declarations.

Has risk assessment checklist as required by the Fire Precautions (Workplace) Regulations 1997 been completed and Conformity demonstrated?

YES / NO*

Relevant Comments / Deviations

Number	Details	Declaration**

- This Certificate is only valid when accompanied by relevant, current:-
- a) Declaration(s) of design, Installation, Commissioning (Appendices 1,2 & 3)
 - b) Photometric Design Calculations
 - c) Test Log Book
 - d) Risk Assessment Checklist

** Delete as appropriate * Design / installation or verification

BS 5266 Pt. I - EMERGENCY LIGHTING SYSTEMS

Design - Declaration of Conformity

BS 5266 Clause Ref.	Installation General Requirements	System complies?		
		Yes	No	N/A
Pt 1 3.2 3.3	Are accurate plans available showing escape routes, fire alarm control panel, call points and fire extinguishers?			
Pt 7 5 Pt 7 4.1	Are acceptable fire safety signs incorporated that are correctly sized, clearly visible and adequately illuminated? Are they located at each door to be used as a final exit? - Where direct line of sight of a final exit is not possible is an illuminated sign positioned indicating the escape route?			
Pt 1 6.10.1	Do the emergency luminaires comply with BS EN 60598-2-22?			
Pt 7 4.1	Are luminaires located at positions necessary to emphasise potential dangers and the locations of safety equipment? (near is within 2 metres horizontally) At each exit door intended to be used in an emergency Near stairs so each tread receives direct light and any other level change Mandatory emergency exits and safety signs At each change of direction and at intersections of corridors Outside and near to each final exit Near each first aid post Near fire fighting equipment and call points			
Pt 1 6.3	Are at least two luminaires illuminating all compartments of the escape route?			
Pt 1 6.8	Is additional emergency lighting provided where needed to illuminate? Lift cars Moving stairways and walkways Toilets, lobbies and closets -larger than 8m2 floor area or without borrowed light Motor generator, control and plant-rooms - Covered car parks			
Pt 1 9.2	Is the mode of operation (maintained or non-maintained) correct?			
Pt 1 9.1	Is the design duration adequate for the application?			
Pt 1 10.6	Have maintenance and testing instructions and a suitable log-book been produced for retention and use by the occupier?			
Pt 7 4.2 Pt 7 4.3 Pt 1 5.3.2	Photometric Requirements Is the spacing within the limits to provide adequate illumination for: - Escape routes for any use. 1 Lux minimum on the center line Open areas above 60 m2 0.5 Lux minimum anywhere in the core area Permanently unobstructed route 0.2 Lux minimum on center line ('A' Deviation) Open Area with an average of at least 1 Lux and a uniformity of 40:1. (Designed to 1988 issue of BS5266 pt. I and checked as acceptable by risk assessment.)			
<p>N B. Photometric design data must be appended – This can be in any of the following formats but in all cases appropriate De-rating factors must be used and identified to meet worst case requirements.</p> <ul style="list-style-type: none"> - Authenticated spacing data such as ICEL 1001 registered tables, - Calculations as detailed in CIBSE Guide TM12 - By appropriate computer print of results. 				
Number -	Comments / Deviations entered on Completion Certificate			

Signature of person making design conformity declaration

For and on behalf of Date.....

BS 5266 Pt. I - EMERGENCY LIGHTING SYSTEMS

Installation - Declaration of Conformity

BS 5266 Clause Ref	Installation General Requirements	System complies?		
		Yes	No	N/A
Pt 7 6.2	1. Does the system installed conform to the agreed design?			
Pt 7 4.1	2. Are all non-maintained luminaires fed or controlled by the final circuit supply of their local normal mains lighting?			
Pt 1 6.5	3. Are the luminaires mounted at least 2 metres above the floor?			
Pt 1 6.5	4. Are they mounted at a height to avoid being located in smoke reservoirs or other likely area of smoke accumulation?			
Pt 1 6.9.2	5. Do the exit signs conform to the signs directive 92/ 58 EEC and are they mounted either between 2 and 2.5 metres high or has an alternative height been agreed with the fire authority?			
Pt 1 8.2.2 8.2.3	6. Do the wiring distribution circuits of central systems provide adequate fire protection and Pt. 1, 8.2.3 are appropriately sized? (BS 7671)			
Pt 1 8.3.5	7. Is the output voltage range of the central power system compatible with the supply voltage range of the luminaires including the effect of supply cable voltage drop?			
60598-2- 22-.6.1	8. Do slave luminaires avoid the use of glow starters in their emergency circuits? (BS EN 60598-2-22)			
Pt 1 8.2.13	9. Are the components of the emergency system part of a fixed installation that does not incorporate plugs and sockets unless they are protected against un-authorized use?			
Pt 1 8.3.3	10. Does the system have suitable and appropriate testing facilities for the specific site?			
Pt 1 11.1	11. Have the equipment manufacturers installation and commissioning procedures been satisfactorily completed?			
Pt 1 8.1	Does the system comply with the general principles of good practice in wiring installations in BS 7671?			
Number -	Comments / Deviations entered on Completion Certificate			

Signature of person making design conformity declaration

For and on behalf ofDate.....

BS 5266 Pt. I - EMERGENCY LIGHTING SYSTEMS

Verification - Declaration of Conformity

Note: Installations shall be verified at least every 5 years

BS 5266 Clause Ref.	Verification General Requirements	System complies?		
		Yes	No	N/A
Pt 1 3.3	1. Are the drawings available and correct?			
Pt 1 8.3.3	2. Does the system have a suitable test facility for the application?			
Pt 1 5.6	3. Are the exit and safety signs correct and visible in normal and emergency conditions?			
Pt 1 3.3	4. Are the luminaires correctly positioned and oriented as shown on the drawings?			
Pt 16.10.1 Pt 7 4.1	5. Do the emergency luminaires comply with BS EN 60598-2-22?			
Pt 1 6.10.1	6. Do the luminaires have an appropriate category of protection against ingress of moisture or foreign bodies for their location as specified in the system design?			
Pt 1 6.10.2	7. Do the enclosures of luminaires located on the escape routes pass the flammability requirements by conforming to the 850°C glow wire test			
Pt 1 9.1	8. Have the luminaires and signs been tested and did they operate for their full rated duration?			
Pt 1 12.4 Pt 7 4.	9. Under test conditions, was adequate illumination provided for safe movement on the escape route and the open areas ? This can be checked by visual inspection and ensuring that the illumination from the luminaires is not obscured and that minimum design spacings have been met.			
Pt 1 12.4	10. After test were the charging indicators operating correctly ?			
Pt 1 8.4	11. Are the wiring requirements satisfactory for fire protection of central systems ?			
Pt 1 8.2.6	12. Are emergency circuits correctly segregated from other supplies			
Pt 1 11.3	13. Have suitable maintenance and testing instructions together with a log-book showing a satisfactory commissioning test been provided for retention and use by the occupier ?			
Pt 1 10.6	14. Has the occupier and their staff been trained on suitable maintenance, testing and operating procedures or has a suitable maintenance contract been agreed			
Additional requirements for checking an existing building				
Pt 1 8.5	15. Are the test records in the log book complete and satisfactory			
	16. Are the luminaires clean and undamaged with lamps in good condition			
	17. Is the original design still valid			
Number -	Comments / Deviations entered on Completion Certificate			

Signature of person making design conformity declaration

For and on behalf ofDate.....

Appendix B

ICEL		Emergency Lighting Installation		
Compliance Checklist for inspection engineers		Issue 2 6-7-2005		
Site Address		Date		
Responsible person				
No.	Checks including those conducted during work in progress	Y	N	N/A
1	Check that the appropriate system has been installed and documented			
1.1	Are the correct areas of the premises covered?			
1.2	Is the system documentation correct and available?			
1.3	Has the system been designed for the correct mode of operation category?			
1.4	Has the system been designed for the correct emergency duration period?			
1.5	Is a completion certificate available with photometric design data?			
1.6	Is a test log available and are the entries up to date?			
2	Check of the system installed			
2.1	Are the luminaires installed those documented in the design?			
2.2	Are the exit signs and arrow directions correct?			
2.3	Are there luminaires sited at the 'points of emphasis'?			
2.4	Is the spacing between luminaires compliant to spacing tables or drawing?			
2.5	Is there illumination from at least two luminaires in each compartment?			
2.6	Are the luminaire housings suitable for their location?			
2.7	Are non maintained luminaires monitoring the local lighting circuit?			
3	Check of the quality of the system			
3.1	Do the luminaires comply to BS EN 60598-2-22?			
3.2	If a central power supply unit is used does it comply to BS EN 50171?			
3.3	For Centrally powered systems is the wiring fire resistant?			
3.4	Do any converted luminaires comply to BS EN 60598-2-22?/ICEL 1004			
4	Test Facilities			
4.1	Do the test facilities simulate a supply failure?			
4.2	Are the test facilities safe to operate and do not isolate a required service?			
4.3	Are the test facilities clearly marked with their function?			
4.4	Is the user staff trained and able to operate them and record correctly?			
4.5	If an automatic test system is installed does it comply wit IEC 62034			
5	Central powered systems			
5.1	Are escape lighting components and cables installed correctly?			
5.2	Can any AC systems start the lamps from the battery in an emergency?			
5.3	Can any AC systems blow all distribution fuses / M.C.B.'s in an emergency?			
6	Final Acceptance to be conducted at completion.			
6.1	Are the areas of coverage in accordance with the requirements imposed under the Building Regulations and the risk assessment?			
6.2	For central systems - has the correct cable type been installed?			
6.3	Does the number and distribution of fittings appear to be reasonable?			
6.4	Have escape lighting cables been segregated from all other cables?			
6.5	Is the standard of cable installation satisfactory?			
6.6	Are all isolators, switches and protective devices minimised and marked?			
6.7	Have suitable test facilities been installed and marked?			
6.8	Have all escape lighting cable penetrations been fire stopped?			
6.9	Does the system operate correctly when tested?			
6.10	Has adequate documentation been provided to the user?			
Results of the Inspection -		Signed		date
Comments				